



Säulenführungsgestelle  
Die sets  
Portastampi  
Jarmi  
Vodící stojánky  
Set ploča

**B** Führungselemente  
Guide elements  
Elementi di guida  
Vodilni elementi  
Vodící elementy  
Vodeći elementi

**C** Schneidelemente  
Cutting elements  
Elementi di taglio  
Rezilni elementi  
Střížné díly  
Rezni elementi

**D** Federelemente  
Springs & elastomers  
Molle ed elastomeri  
Vzmeti in elastomeri  
Pružiny a elastomery  
Opruge i poliuretani

**E** Zubehör  
Accessories  
Accessori  
Pripomočki  
Příslušenství  
Vezni elementi

**F** Info





## 1112 ISO

## 1122 ISO

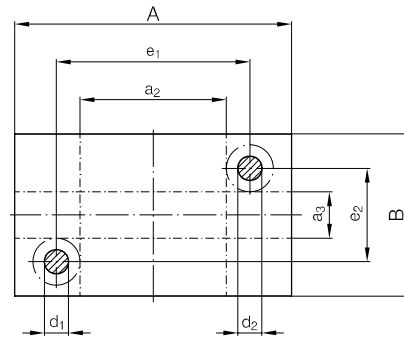
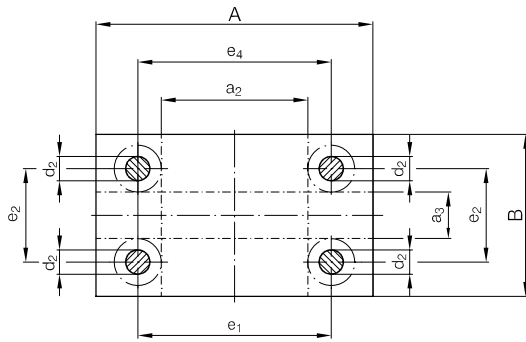

## 1132 ISO

## 1142 ISO

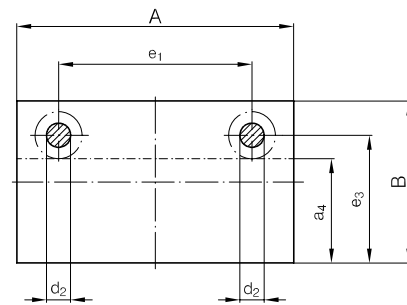
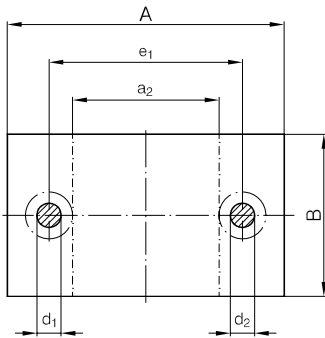

$a_2 \times B$	$A \times a_3$	$A \times a_4$	$d_1$	$d_2$	$e_1$	$e_2$	$e_3$	$e_4$	$c_1$	$c_2$	$Y$	$A \times B$							
60 x 80	-	-	19	20	100	-	-	-	32	32	1	160 x 80							
60 x 100	-	160 x 50					70		32	32	1	160 x 100							
60 x 125	-	160 x 75					95		32	32	1	160 x 125							
60 x 160	160 x 60	160 x 110	24	25	120	100	130	103	32	32	1	160 x 160							
70 x 100	-	-							40	40	1	-	-	-	40	40	2	200 x 100	
									32	40	3				40	32	2		200 x 125
									32	32	4				40	40	1		
									40	32	2				40	40	1		200 x 200
40	40	1							40	32	2	250 x 125							
32	40	3							32	32	4		250 x 160						
40	40	1							40	40	1	250 x 200							
40	32	2							40	32	2		250 x 250						
32	40	3							32	40	3			315 x 160					
32	32	4							40	40	1		315 x 160						
40	40	1							50	50	1	315 x 160							
40	32	2							50	40	2			315 x 160					
32	40	3							40	50	3				315 x 160				
32	32	4							40	40	4		315 x 160						
50	50	1							50	40	2	315 x 160							
40	40	4							40	40	4			315 x 160					



a <sub>2</sub> x B	A x a <sub>3</sub>	A x a <sub>4</sub>	d <sub>1</sub>	d <sub>2</sub>	e <sub>1</sub>	e <sub>2</sub>	e <sub>3</sub>	e <sub>4</sub>	c <sub>1</sub>	c <sub>2</sub>	Y	A x B		
165 x 200	315 x 50	315 x 125	30	32	225	110	155	228	50	50	1	315 x 200		
									50	40	2			
									40	50	3			
									40	40	4			
50	50	1				315 x 250								
50	40	2												
40	50	3												
40	40	4												
165 x 250	315 x 100	315 x 175			30	32	225	110	155	228	50	50	1	315 x 315
											50	40	2	
											40	50	3	
											40	40	4	
50	50	1	400 x 200											
50	40	2												
40	50	3												
40	40	4												
165 x 315	315 x 165	315 x 240	30	32	225	110	155	228	50	50	1	400 x 250		
									50	40	2			
									40	50	3			
									40	40	4			
50	50	1				400 x 315								
50	40	2												
40	50	3												
40	40	4												
250 x 200	400 x 50	400 x 125	38	40	400	150	200	403	50	50	1	500 x 250		
									50	40	2			
									40	50	3			
									40	40	4			
50	50	1				500 x 315								
50	40	2												
40	50	3												
40	40	4												
250 x 250	400 x 100	400 x 175			38	40	400	150	200	403	50	50	1	500 x 400
											50	40	2	
											40	50	3	
											40	40	4	
50	50	1	500 x 500											
50	40	2												
40	50	3												
40	40	4												
250 x 315	400 x 165	400 x 240	48	50	510	195	255	513	63	63	1	630 x 315		
									63	50	2			
									50	63	3			
									50	50	4			
63	63	1				630 x 400								
63	50	2												
50	63	3												
50	50	4												
250 x 400	400 x 250	400 x 325			48	50	510	195	255	513	63	63	1	630 x 500
											63	50	2	
											50	63	3	
											50	50	4	
63	63	1	630 x 630											
63	50	2												
50	63	3												
50	50	4												
330 x 250	500 x 80	500 x 165	48	50	590	280	340	593	63	63	1	710 x 400		
									63	50	2			
									50	63	3			
									50	50	4			
63	63	1				710 x 500								
63	50	2												
50	63	3												
50	50	4												
330 x 315	500 x 145	500 x 240			48	50	590	280	340	593	63	63	1	710 x 630
											63	50	2	
											50	63	3	
											50	50	4	
63	63	1	800 x 400											
63	50	2												
50	63	3												
50	50	4												
330 x 400	500 x 240	500 x 315	48	50	590	280	340	593	63	63	1	800 x 500		
									63	50	2			
									50	63	3			
									50	50	4			
63	63	1				800 x 630								
63	50	2												
50	63	3												
50	50	4												
330 x 500	500 x 330	500 x 415	48	50	680	280	340	683	63	63	1	800 x 400		
									63	50	2			
									50	63	3			
									50	50	4			
63	63	1				800 x 500								
63	50	2												
50	63	3												
50	50	4												
430 x 315	630 x 115	630 x 215	48	50	680	280	340	683	63	63	1	800 x 400		
									63	50	2			
									50	63	3			
									50	50	4			
63	63	1				800 x 500								
63	50	2												
50	63	3												
50	50	4												
430 x 400	630 x 200	630 x 300			48	50	680	280	340	683	63	63	1	800 x 630
											63	50	2	
											50	63	3	
											50	50	4	
63	63	1	800 x 630											
63	50	2												
50	63	3												
50	50	4												
430 x 500	630 x 300	630 x 400	48	50	680	280	340	683	63	63	1	800 x 630		
									63	50	2			
									50	63	3			
									50	50	4			
63	63	1				800 x 630								
63	50	2												
50	63	3												
50	50	4												
430 x 630	630 x 430	630 x 530	48	50	680	280	340	683	63	63	1	800 x 630		
									63	50	2			
									50	63	3			
									50	50	4			
63	63	1				800 x 630								
63	50	2												
50	63	3												
50	50	4												
510 x 400	710 x 200	710 x 300	48	50	680	280	340	683	63	63	1	800 x 630		
									63	50	2			
									50	63	3			
									50	50	4			
63	63	1				800 x 630								
63	50	2												
50	63	3												
50	50	4												
510 x 500	710 x 300	710 x 400	48	50	680	280	340	683	63	63	1	800 x 630		
									63	50	2			
									50	63	3			
									50	50	4			
63	63	1				800 x 630								
63	50	2												
50	63	3												
50	50	4												
510 x 630	710 x 430	710 x 530	48	50	680	280	340	683	63	63	1	800 x 630		
									63	50	2			
									50	63	3			
									50	50	4			
63	63	1				800 x 630								
63	50	2												
50	63	3												
50	50	4												
600 x 400	800 x 200	800 x 300	48	50	680	280	340	683	63	63	1	800 x 630		
									63	50	2			
									50	63	3			
									50	50	4			
63	63	1				800 x 630								
63	50	2												
50	63	3												
50	50	4												
600 x 500	800 x 300	800 x 400	48	50	680	280	340	683	63	63	1	800 x 630		
									63	50	2			
									50	63	3			
									50	50	4			
63	63	1				800 x 630								
63	50	2												
50	63	3												
50	50	4												
600 x 630	800 x 430	800 x 530	48	50	680	280	340	683	63	63	1	800 x 630		
									63	50	2			
									50	63	3			
									50	50	4			
63	63	1				800 x 630								
63	50	2												
50	63	3												
50	50	4												

BITTE KOPIEREN  
PLEASE COPY  
COPIARE PREGO  
PROSIMO KOPIRAJTE  
ZKOPIRUJTE PROSIM  
MOLIMO KOPIRAJTE

Normgestelle  
Standard die sets  
Portastampi standard  
Standardni jarmi  
Standardni vodíci stojánky  
Standardni set ploča

c<sub>2</sub>  
c<sub>1</sub>

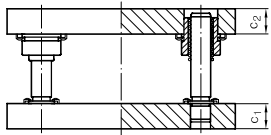

**P2**  
Platte 2 / Plate 2  
Piastra 2 / Plošča 2  
Deska 2 / Ploča 2

**P1**  
Platte 1 / Plate 1  
Piastra 1 / Plošča 1  
Deska 1 / Ploča 1

## 1112 ISO

A x B

e<sub>1</sub>  
e<sub>2</sub>  
e<sub>4</sub>  
a<sub>2</sub>  
a<sub>3</sub>  
d<sub>2</sub>

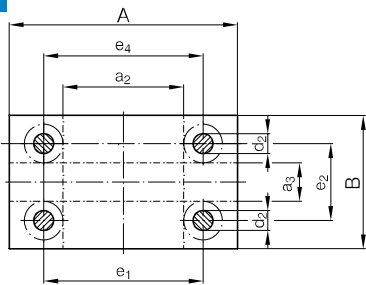

## 1122 ISO

A x B

e<sub>1</sub>  
e<sub>2</sub>  
a<sub>2</sub>  
a<sub>3</sub>  
d<sub>1</sub>  
d<sub>2</sub>

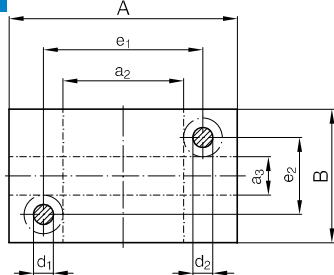

## 1132 ISO

A x B

e<sub>1</sub>  
a<sub>2</sub>  
d<sub>1</sub>  
d<sub>2</sub>

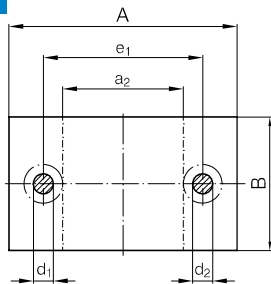

## 1142 ISO

A x B

e<sub>1</sub>  
e<sub>3</sub>  
a<sub>4</sub>  
d<sub>2</sub>

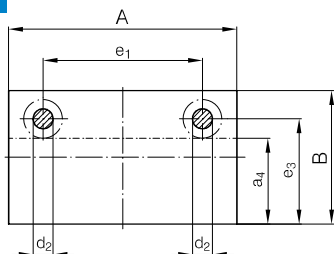

## Führungssäulen / Guide pillars / Colonne di guida / Vodilni stebri / Vodící sloupky / Vodecí stubovi

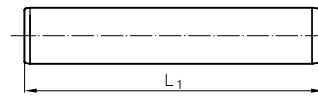

1200 ISO

**P1**

L<sub>1</sub> = \_\_\_\_\_

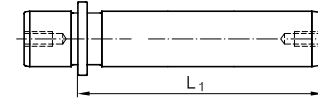

1210 ISO

**P1**

L<sub>1</sub> = \_\_\_\_\_

## Gleitführung / Slide bearing / Guida scorrevole / Dršno vodenje / Kluzné vedení / Klizno vodenje

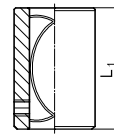

1230 ISO

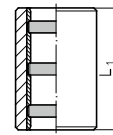

1240 ISO

**P2**

12\_\_ ISO L<sub>1</sub> = \_\_\_\_\_

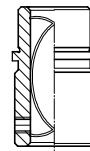

1231\_\_ ISO

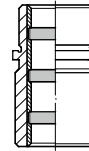

1241\_\_ ISO

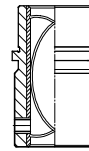

1243\_\_ ISO

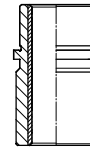

1246\_\_ ISO

**P2**

12\_\_ ISO

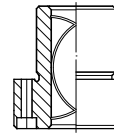

1232\_\_ ISO

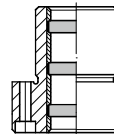

1242\_\_ ISO

**P2**

12\_\_ ISO

## Kugelführung / Ball bearing / Guida a sfere / Kroglično vodenje / Kuličkové vedení / Kuglično vodenje

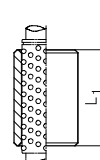

1250 ISO

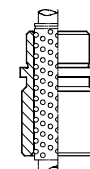

1251\_\_ ISO

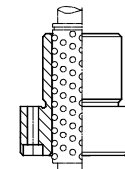

1252\_\_ ISO

**P2**

L<sub>1</sub> = \_\_\_\_\_  1251\_\_ ISO  1252\_\_ ISO

**H**

**V**

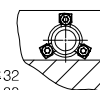

3 x d<sub>1</sub>=32  
4 x d<sub>1</sub>=38

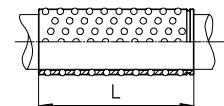
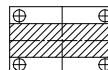
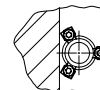

1259 ISO

**P2** L = \_\_\_\_\_

## 1113 ISO

## 1123 ISO

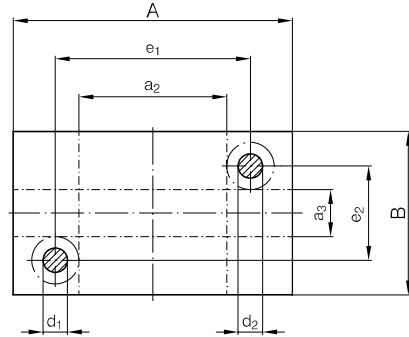
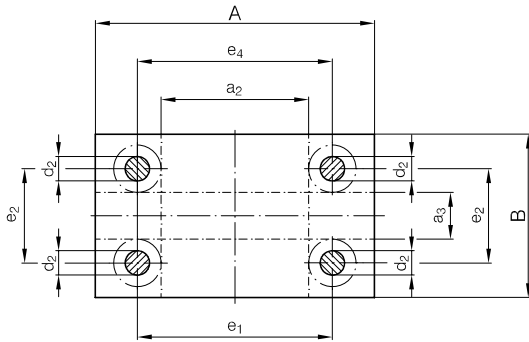

## 1133 ISO

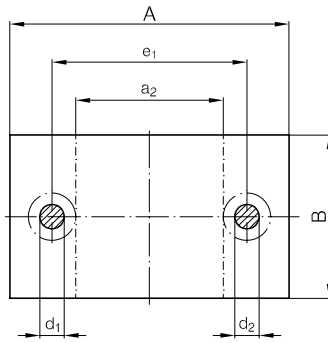

a <sub>2</sub> x B	A x a <sub>3</sub>	d <sub>1</sub>	d <sub>2</sub>	e <sub>1</sub>	e <sub>2</sub>	e <sub>4</sub>	c <sub>1</sub>	c <sub>2</sub>	c <sub>3</sub>	Y	A x B												
60 x 80	-	19	20	100	-	-	32	32	25	1	160 x 80												
60 x 100							32	32		1	160 x 100												
60 x 125							32	32		1	160 x 125												
60 x 160							32	32		1	160 x 160												
70 x 100	-	24	25	120	-	-	40	40		1	200 x 100												
							40	32		2													
							32	40		3													
							32	32		4													
70 x 125							-	24		25	120	-	-	40	40	1	200 x 125						
														40	32	2							
														32	40	3							
														32	32	4							
70 x 160									-					24	25	120	-	-	40	40	1	200 x 160	
																			40	32	2		
																			32	40	3		
																			32	32	4		
70 x 200	200 x 70	24	25	120	120	123													40	40	1	200 x 200	
																			40	32	2		
																			32	40	3		
																			32	32	4		
120 x 125							-	24		25	170	-	-						40	40	1	250 x 125	
																			40	32	2		
																			32	40	3		
																			32	32	4		
120 x 160									-					24	25	170	-	-	40	40	1	250 x 160	
																			40	32	2		
																			32	40	3		
																			32	32	4		
120 x 200	250 x 70	24	25	170	120	173													40	40	1	250 x 200	
																			40	32	2		
																			32	40	3		
																			32	32	4		
120 x 250							250 x 120	24		25	170	170	173						40	40	1	250 x 250	
																			40	32	2		
																			32	40	3		
																			32	32	4		
165 x 160									-					30	32	225	-	-	50	50	32	1	315 x 160
																			50	40		2	
																			40	50		3	
																			40	40		4	



a <sub>2</sub> x B	A x a <sub>3</sub>	d <sub>1</sub>	d <sub>2</sub>	e <sub>1</sub>	e <sub>2</sub>	e <sub>4</sub>	C <sub>1</sub>	C <sub>2</sub>	C <sub>3</sub>	Y	A x B									
165 x 200	315 x 50	30	32	225	110	228	50	50	32	1	315 x 200									
							50	40		2										
							40	50		3										
							40	40		4										
50	50				1															
50	40				2															
40	50				3															
40	40				4															
165 x 250	315 x 100			30	32	225	160	228		50	50	32	1	315 x 250						
										50	40		2							
										40	50		3							
										40	40		4							
50	50	1																		
50	40	2																		
40	50	3																		
40	40	4																		
165 x 315	315 x 165	30	32			225	225	228	50	40	32		2	315 x 315						
									40	50			3							
									40	40			4							
									50	50			1							
50	40			2																
40	50			3																
40	40			4																
250 x 200	400 x 50			30	32		310		110	313		50	50		32	1	400 x 200			
						50		40				2								
						40		50				3								
						40		40				4								
50	50					1														
50	40	2																		
40	50	3																		
40	40	4																		
250 x 250	400 x 100	30	32			310	160	313	50	50	32	1	400 x 250							
									50	40		2								
									40	50		3								
									40	40		4								
50	50			1																
50	40			2																
40	50			3																
40	40			4																
250 x 315	400 x 165			30	32	310	225	313	50	50		32	1	400 x 315						
									50	40			2							
									40	50			3							
									40	40			4							
50	50	1																		
50	40	2																		
40	50	3																		
40	40	4																		
250 x 400	400 x 250	30	32			310	310	313	50	50	32		1	400 x 400						
									50	40			2							
									40	50			3							
									40	40			4							
50	50			1																
50	40			2																
40	50			3																
40	40			4																
330 x 250	500 x 80			38	40	400	150	403	50	50		32	1	500 x 250						
									50	40			2							
									40	50			3							
									40	40			4							
50	50	1																		
50	40	2																		
40	50	3																		
40	40	4																		
330 x 315	500 x 145	38	40			400	215	403	50	50	32		1	500 x 315						
									50	40			2							
									40	50			3							
									40	40			4							
50	50			1																
50	40			2																
40	50			3																
40	40			4																
330 x 400	500 x 240			38	40	400	300	403	50	50		32	1	500 x 400						
									50	40			2							
									40	50			3							
									40	40			4							
50	50	1																		
50	40	2																		
40	50	3																		
40	40	4																		
330 x 500	500 x 330	38	40			400	400	403	50	50	32		1	500 x 500						
									50	40			2							
									40	50			3							
									40	40			4							
50	50			1																
50	40			2																
40	50			3																
40	40			4																
430 x 315	630 x 115			48	50	510	195	513	63	63		40	1	630 x 315						
									63	50			2							
									50	63			3							
									50	50			4							
63	63	1																		
63	50	2																		
50	63	3																		
50	50	4																		
430 x 400	630 x 200	48	50				510		280	513	63		63		40	1	630 x 400			
											63		50			2				
											50		63			3				
											50		50			4				
63	63					1														
63	50					2														
50	63					3														
50	50					4														
430 x 500	630 x 300					48		50	510		380		513	63		63		40	1	630 x 500
														63		50			2	
														50		63			3	
														50		50			4	
63	63						1													
63	50						2													
50	63						3													
50	50						4													
430 x 630	630 x 430			48	50		510			510	513	63		63		40	1		630 x 630	
												63		50			2			
												50		63			3			
												50		50			4			
63	63								1											
63	50								2											
50	63								3											
50	50								4											
510 x 400	710 x 200	48	50						590	280		593	63	63	40		1			710 x 400
													63	50			2			
													50	63			3			
													50	50			4			
63	63						1													
63	50						2													
50	63						3													
50	50						4													
510 x 500	710 x 300					48	50	590		380	593		63	63			40	1	710 x 500	
													63	50				2		
													50	63				3		
													50	50				4		
63	63								1											
63	50								2											
50	63								3											
50	50								4											
510 x 630	710 x 430			48	50				590	510		593	63	63		40		1		710 x 630
													63	50				2		
													50	63				3		
													50	50				4		
63	63							1												
63	50							2												
50	63							3												
50	50							4												
600 x 400	800 x 200	48	50					680		280	683		63	63	40			1	800 x 400	
													63	50				2		
													50	63				3		
													50	50				4		
63	63								1											
63	50								2											
50	63								3											
50	50								4											
600 x 500	800 x 300					48	50		680	380		683	63	63			40	1		800 x 500
													63	50				2		
													50	63				3		
													50	50				4		
63	63							1												
63	50							2												
50	63							3												
50	50							4												
600 x 630	800 x 430			48	50			680		510	683		63	63		40		1	800 x 630	
													63	50				2		
													50	63				3		
													50	50				4		
63	63								1											
63	50								2											
50	63								3											
50	50								4											

BITTE KOPIEREN  
PLEASE COPY  
COPIARE PREGO  
PROSIMO KOPIRAJTE  
ZKOPIRUJTE PROSIM  
MOLIMO KOPIRAJTE

Normgestelle  
Standard die sets  
Portastampi standard  
Standardni jarmi  
Standardni vodící stojánky  
Standardni set ploča

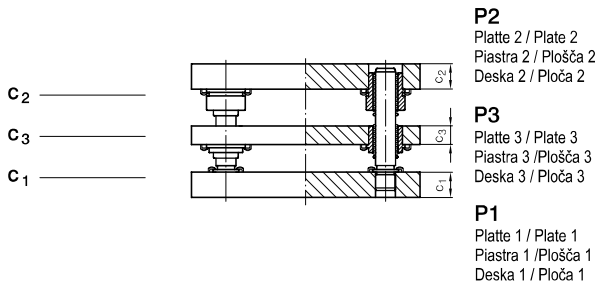

**1113 ISO**  A \_\_\_\_\_ x B \_\_\_\_\_

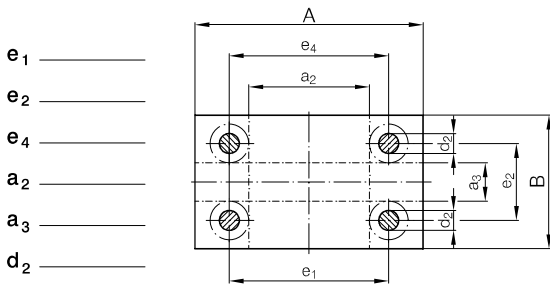

**1123 ISO**  A \_\_\_\_\_ x B \_\_\_\_\_

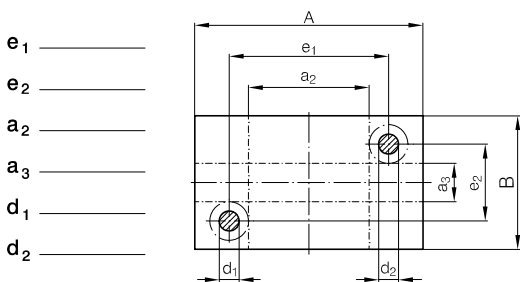

**1133 ISO**  A \_\_\_\_\_ x B \_\_\_\_\_

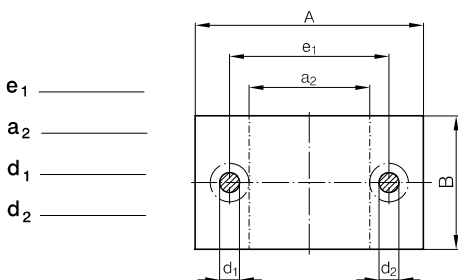

Führungssäulen / Guide pillars / Colonne di guida /  
Vodilni stebri / Vodící sloupky / Vodecí stubovi

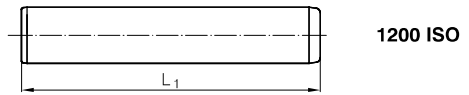

**P1**  L1 = \_\_\_\_\_

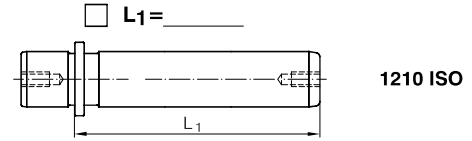

**P1**  L1 = \_\_\_\_\_

Gleitführung / Slide bearing / Guida scorrevole /  
Dršno vodenje / Kluzné vedení / Klizno vodenje

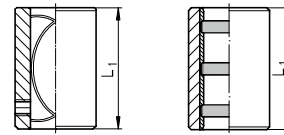

**1230 ISO**      **1240 ISO**

**P2**  12\_\_ \_\_ ISO L1 = \_\_\_\_\_

**P3**  12\_\_ \_\_ ISO L1 = \_\_\_\_\_

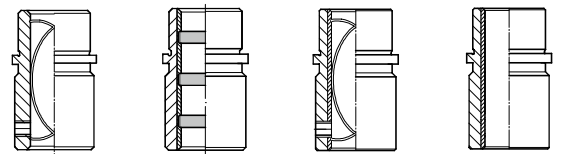

**1231\_\_ ISO**      **1241\_\_ ISO**      **1243\_\_ ISO**      **1246\_\_ ISO**

**P2**  12\_\_ \_\_ ISO

**P3**  12\_\_ \_\_ ISO

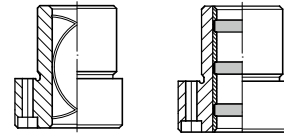

**1232\_\_ ISO**      **1242\_\_ ISO**

**P2**  12\_\_ \_\_ ISO

**P3**  12\_\_ \_\_ ISO

Kugelführung / Ball bearing / Guida a sfere /  
Kroglično vodenje / Kuličkové vedení / Kuglično vodenje

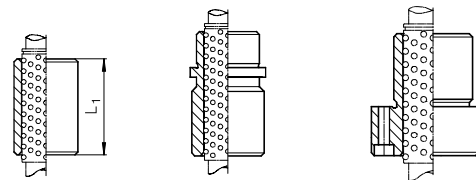

**1250 ISO**      **1251\_\_ ISO**      **1252\_\_ ISO**

**P2**  L1 = \_\_\_\_\_  1251\_\_ ISO  1252\_\_ ISO

**P3**  L1 = \_\_\_\_\_  1251\_\_ ISO  1252\_\_ ISO

**H**  **V**

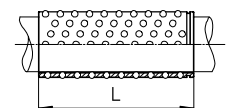

**1259 ISO**

**P2** L = \_\_\_\_\_

**P3** L = \_\_\_\_\_



## INFO

Säulengestelle toleranzen  
Die Sets Tolerances  
Tolleranze portastampi

Tolerance jarmov  
Tolerance vodících stojáneků  
Tolerancije seta ploča

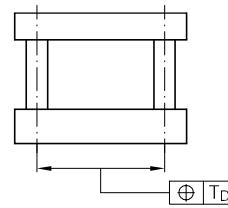
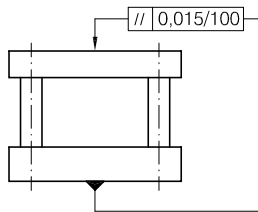
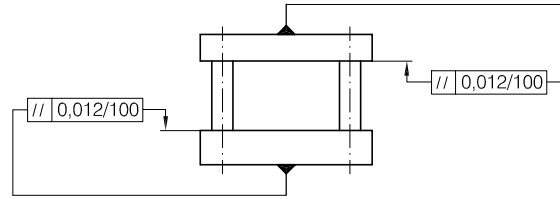
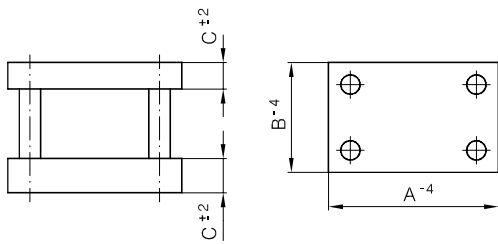

T <sub>D</sub>		
-	100 mm	= ± 0,008 mm
>	100 - 180 mm	= ± 0,010 mm
>	180 - 350 mm	= ± 0,012 mm
>	350 - 500 mm	= ± 0,015 mm
>	500 - 710 mm	= ± 0,018 mm
>	710 - 1000 mm	= ± 0,020 mm

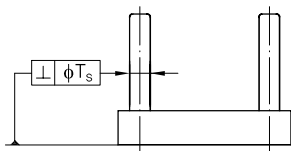

T<sub>s</sub> = 0,012/100mm

